

Balanced Detection

2008.6.19 Jun

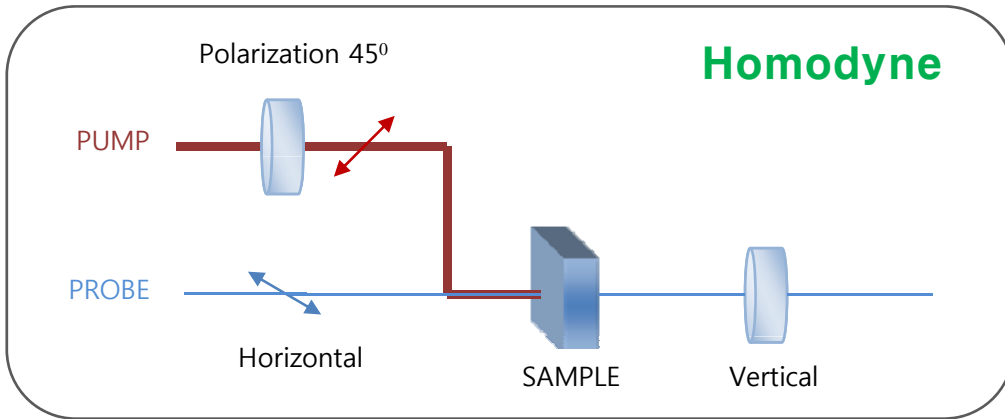

$$\sin\left(\frac{\phi_x - \phi_y}{2}\right)^2$$

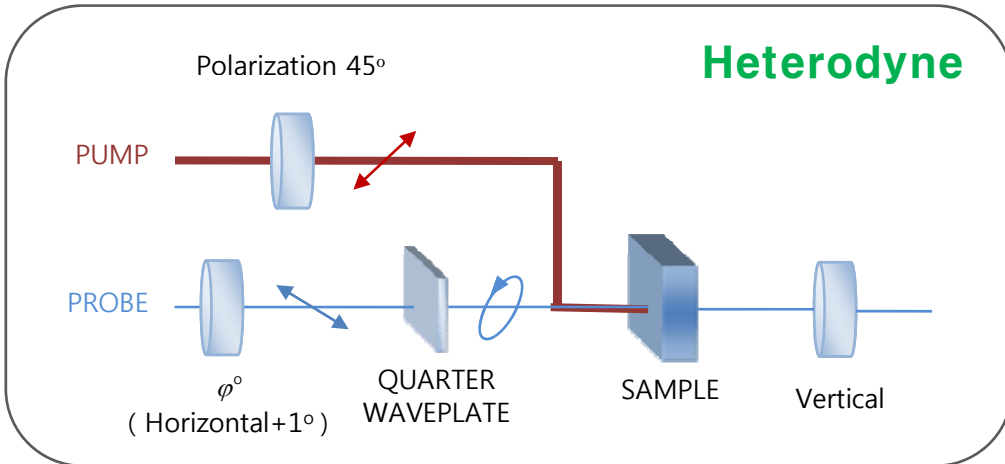

$$0.000306 - 0.000153 \sin\left(\frac{\phi_x - \phi_y}{2}\right)^2$$

$$+(5.35 \times 10^{-6}) \sin(\phi_x - \phi_y)$$

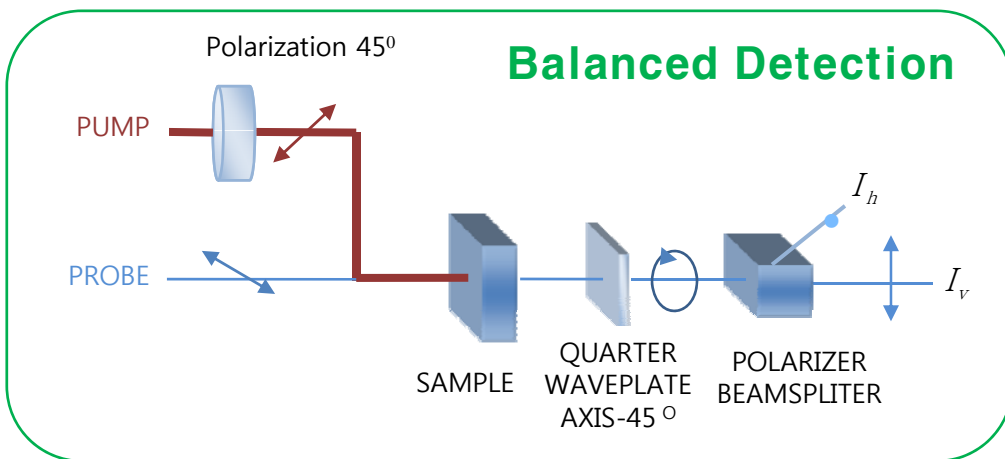

$$\sin(\phi_x - \phi_y)$$

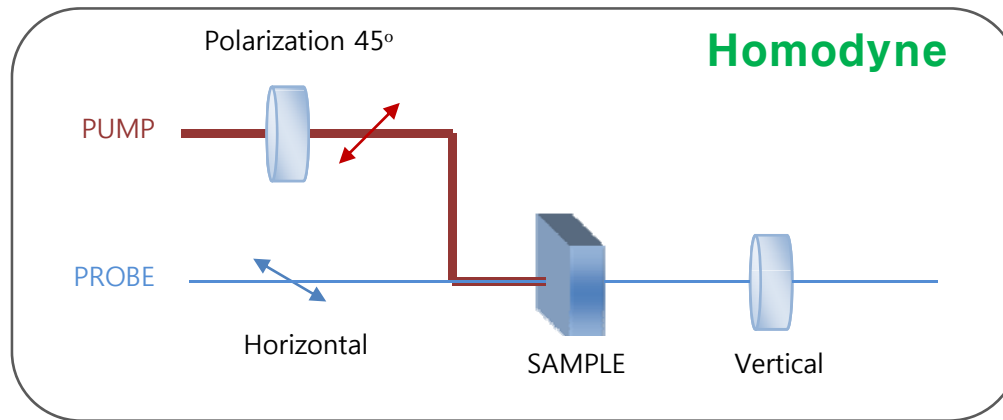

incident beam vector : horizontal $\begin{pmatrix} 1 \\ 0 \end{pmatrix}$

analyzer : vertical $\begin{pmatrix} 0 & 0 \\ 0 & 1 \end{pmatrix}$

sample (relative phase changer) (pump beam polarizer 45°) :

$$\begin{pmatrix} \cos 45^\circ & -\sin 45^\circ \\ \sin 45^\circ & \cos 45^\circ \end{pmatrix} \begin{pmatrix} e^{i\phi_x} & 0 \\ 0 & e^{i\phi_y} \end{pmatrix} \begin{pmatrix} \cos 45^\circ & \sin 45^\circ \\ -\sin 45^\circ & \cos 45^\circ \end{pmatrix} = \begin{pmatrix} \frac{e^{i\phi_x}}{2} + \frac{e^{i\phi_y}}{2} & \frac{e^{i\phi_x}}{2} - \frac{e^{i\phi_y}}{2} \\ \frac{e^{i\phi_x}}{2} - \frac{e^{i\phi_y}}{2} & \frac{e^{i\phi_x}}{2} + \frac{e^{i\phi_y}}{2} \end{pmatrix}$$

$$\begin{aligned}
\begin{pmatrix} E_h \\ E_v \end{pmatrix} &= \frac{1}{2} \begin{pmatrix} 1 & -1 \\ -1 & 1 \end{pmatrix} \begin{pmatrix} \frac{e^{i\phi_x}}{2} + \frac{e^{i\phi_y}}{2} & \frac{e^{i\phi_x}}{2} - \frac{e^{i\phi_y}}{2} \\ \frac{e^{i\phi_x}}{2} - \frac{e^{i\phi_y}}{2} & \frac{e^{i\phi_x}}{2} + \frac{e^{i\phi_y}}{2} \end{pmatrix} \begin{pmatrix} 0 & 0 \\ 0 & 1 \end{pmatrix} \begin{pmatrix} 1 \\ 0 \end{pmatrix} \\
&= \begin{pmatrix} 0 \\ \frac{e^{i\phi_x}}{2} - \frac{e^{i\phi_y}}{2} \end{pmatrix}
\end{aligned}$$

$$I \propto (E_h E_h^*) + (E_v E_v^*)$$

$$E_v E_v^* = \left(\frac{e^{i\phi_x}}{2} - \frac{e^{i\phi_y}}{2} \right) \times \left(\frac{e^{-i\phi_x}}{2} - \frac{e^{-i\phi_y}}{2} \right)$$

$$= \frac{1}{4} \cos^2 \phi_x - \frac{1}{2} \cos \phi_x \cos \phi_y + \frac{1}{4} \cos^2 \phi_y + \frac{1}{4} \sin^2 \phi_x - \frac{1}{2} \sin \phi_x \sin \phi_y + \frac{1}{4} \sin^2 \phi_y$$

$$= \sin^2 \left(\frac{\phi_x - \phi_y}{2} \right)$$

$$I \propto \sin^2 \left(\frac{\phi_x - \phi_y}{2} \right)$$

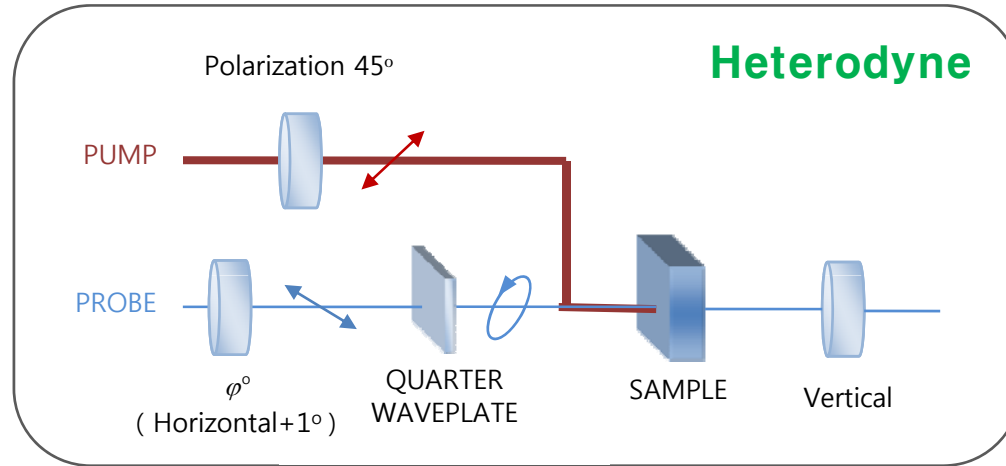

incident beam vector : horizontal $\begin{pmatrix} 1 \\ 0 \end{pmatrix}$

polarizer : angle φ ($46 \leq \varphi$)

$$\begin{pmatrix} \cos \varphi & -\sin \varphi \\ \sin \varphi & \cos \varphi \end{pmatrix} \begin{pmatrix} 1 & 0 \\ 0 & 0 \end{pmatrix} \begin{pmatrix} \cos \varphi & \sin \varphi \\ -\sin \varphi & \cos \varphi \end{pmatrix} = \begin{pmatrix} \cos^2 \varphi & \sin \varphi \cos \varphi \\ \sin \varphi \cos \varphi & \sin^2 \varphi \end{pmatrix}$$

quarter waveplate : fast axis \rightarrow horizontal $\begin{pmatrix} 1 & 0 \\ 0 & i \end{pmatrix}$

analyzer : vertical $\begin{pmatrix} 0 & 0 \\ 0 & 1 \end{pmatrix}$

sample (relative phase changer) (pump beam polarizer 45°) :

$$\begin{pmatrix} \cos 45^\circ & -\sin 45^\circ \\ \sin 45^\circ & \cos 45^\circ \end{pmatrix} \begin{pmatrix} e^{i\phi_x} & 0 \\ 0 & e^{i\phi_y} \end{pmatrix} \begin{pmatrix} \cos 45^\circ & \sin 45^\circ \\ -\sin 45^\circ & \cos 45^\circ \end{pmatrix} = \begin{pmatrix} \frac{e^{i\phi_x}}{2} + \frac{e^{i\phi_y}}{2} & \frac{e^{i\phi_x}}{2} - \frac{e^{i\phi_y}}{2} \\ \frac{e^{i\phi_x}}{2} - \frac{e^{i\phi_y}}{2} & \frac{e^{i\phi_x}}{2} + \frac{e^{i\phi_y}}{2} \end{pmatrix}$$

$$\begin{pmatrix} E_h \\ E_v \end{pmatrix} = \begin{pmatrix} 0 & 0 \\ 0 & 1 \end{pmatrix} \begin{pmatrix} \frac{e^{i\phi_x} + e^{i\phi_y}}{2} & \frac{e^{i\phi_x} - e^{i\phi_y}}{2} \\ \frac{e^{i\phi_x} - e^{i\phi_y}}{2} & \frac{e^{i\phi_x} + e^{i\phi_y}}{2} \end{pmatrix} \begin{pmatrix} 0 & 0 \\ 0 & i \end{pmatrix} \begin{pmatrix} \cos^2 \varphi & \sin \varphi \cos \varphi \\ \sin \varphi \cos \varphi & \sin^2 \varphi \end{pmatrix} \begin{pmatrix} 1 \\ 0 \end{pmatrix}$$

$$= \begin{pmatrix} 0 \\ \cos \varphi \left(\left(\frac{e^{i\phi_x} - e^{i\phi_y}}{2} \right) \cos \varphi + i \left(\frac{e^{i\phi_x} + e^{i\phi_y}}{2} \right) \sin \varphi \right) \end{pmatrix}$$

$$\therefore I \propto (E_h E_h^*) + (E_v E_v^*)$$

$$\begin{aligned} E_v E_v^* &= \left(\cos \varphi \left(\left(\frac{e^{i\phi_x} - e^{i\phi_y}}{2} \right) \cos \varphi + i \left(\frac{e^{i\phi_x} + e^{i\phi_y}}{2} \right) \sin \varphi \right) \right) \times \left(\cos \varphi \left(\left(\frac{e^{-i\phi_x} - e^{-i\phi_y}}{2} \right) \cos \varphi - i \left(\frac{e^{-i\phi_x} + e^{-i\phi_y}}{2} \right) \sin \varphi \right) \right) \\ &= \frac{1}{4} \cos^4 \varphi \cos^2 \phi_x - \frac{1}{2} \cos^4 \varphi \cos \phi_x \cos \phi_y + \frac{1}{4} \cos^4 \varphi \cos^2 \phi_y + \frac{1}{4} \cos^2 \varphi \cos^2 \phi_x \sin^2 \varphi \\ &\quad + \frac{1}{2} \cos^2 \varphi \cos \phi_x \cos \phi_y \sin^2 \varphi + \frac{1}{4} \cos^2 \varphi \cos^2 \phi_y \sin^2 \varphi + \cos^3 \varphi \cos \phi_y \sin \varphi \sin \phi_x \\ &\quad + \frac{1}{4} \cos^4 \varphi \sin^2 \phi_x + \frac{1}{4} \cos^2 \varphi \sin^2 \varphi \sin^2 \phi_x - \cos^3 \varphi \cos \phi_x \sin \varphi \sin \phi_y - \frac{1}{2} \cos^4 \varphi \sin \phi_x \sin \phi_y \\ &\quad + \frac{1}{2} \cos^2 \varphi \sin^2 \varphi \sin \phi_x \sin \phi_y + \frac{1}{4} \cos^4 \varphi \sin \phi_y + \frac{1}{4} \cos^2 \varphi \sin^2 \varphi \sin \phi_y \\ &= 0.000306 - 0.000153 \sin\left(\frac{\phi_x - \phi_y}{2}\right)^2 + (5.35 \times 10^{-6}) \sin(\phi_x - \phi_y) \end{aligned}$$

$$I \propto 0.000306 - 0.000153 \sin\left(\frac{\phi_x - \phi_y}{2}\right)^2 + (5.35 \times 10^{-6}) \sin(\phi_x - \phi_y)$$

(※ $\cos \varphi, \sin \varphi$ 의 Taylor expansion

$\varphi = \delta$ (※ $\delta \approx 1^\circ \approx 0.0175 \text{ rad}$)

$$\cos(\delta) = \cos 0 - \delta \sin 0 - \frac{1}{2} \delta^2 \cos 0 + \dots \cong 1 - \frac{1}{2} \delta^2 = 0.9998$$

$$\sin(\delta) = \sin 0 + \delta \cos 0 - \frac{1}{2} \delta^2 \sin 0 + \dots \cong \delta = 0.0175$$

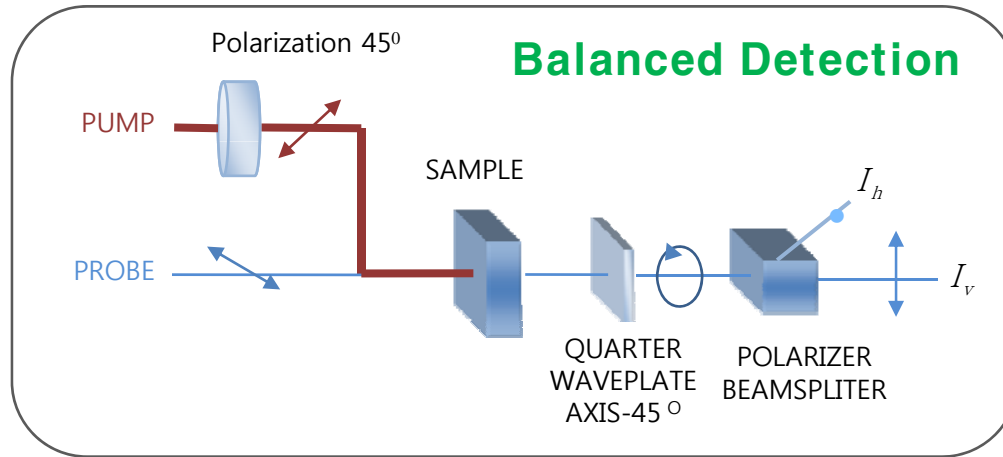

incident beam vector : horizontal $\begin{pmatrix} 1 \\ 0 \end{pmatrix}$

sample (relative phase changer) (pump beam polarizer 45°) :

$$\begin{pmatrix} \cos 45^\circ & -\sin 45^\circ \\ \sin 45^\circ & \cos 45^\circ \end{pmatrix} \begin{pmatrix} e^{i\phi_x} & 0 \\ 0 & e^{i\phi_y} \end{pmatrix} \begin{pmatrix} \cos 45^\circ & \sin 45^\circ \\ -\sin 45^\circ & \cos 45^\circ \end{pmatrix} = \begin{pmatrix} \frac{e^{i\phi_x}}{2} + \frac{e^{i\phi_y}}{2} & \frac{e^{i\phi_x}}{2} - \frac{e^{i\phi_y}}{2} \\ \frac{e^{i\phi_x}}{2} - \frac{e^{i\phi_y}}{2} & \frac{e^{i\phi_x}}{2} + \frac{e^{i\phi_y}}{2} \end{pmatrix}$$

quarter waveplate : fast axis $\rightarrow -45^\circ$ $\frac{1}{\sqrt{2}} \begin{pmatrix} 1 & -i \\ -i & 1 \end{pmatrix}$

$$\begin{pmatrix} E_h \\ E_v \end{pmatrix} = \frac{1}{\sqrt{2}} \begin{pmatrix} 1 & -i \\ -i & 1 \end{pmatrix} \begin{pmatrix} \frac{e^{i\phi_x}}{2} + \frac{e^{i\phi_y}}{2} & \frac{e^{i\phi_x}}{2} - \frac{e^{i\phi_y}}{2} \\ \frac{e^{i\phi_x}}{2} - \frac{e^{i\phi_y}}{2} & \frac{e^{i\phi_x}}{2} + \frac{e^{i\phi_y}}{2} \end{pmatrix} \begin{pmatrix} 1 \\ 0 \end{pmatrix} = \begin{pmatrix} \frac{(\frac{1}{2} - \frac{i}{2})e^{i\phi_x} + (\frac{1}{2} + \frac{i}{2})e^{i\phi_y}}{\sqrt{2}} \\ \frac{(\frac{1}{2} - \frac{i}{2})e^{i\phi_x} - (\frac{1}{2} + \frac{i}{2})e^{i\phi_y}}{\sqrt{2}} \end{pmatrix}$$

$$\begin{aligned}
I_h - I_v &\propto (E_h E_h^*) - (E_v E_v^*) \\
(E_h E_h^*) - (E_v E_v^*) &= \left(\frac{\left(\frac{1-i}{2}\right)e^{i\phi_x} + \left(\frac{1+i}{2}\right)e^{i\phi_y}}{\sqrt{2}} \right) \times \left(\frac{\left(\frac{1-i}{2}\right)e^{-i\phi_x} + \left(\frac{1+i}{2}\right)e^{-i\phi_y}}{\sqrt{2}} \right) \\
&\quad - \left(\frac{\left(\frac{1-i}{2}\right)e^{i\phi_x} - \left(\frac{1+i}{2}\right)e^{i\phi_y}}{\sqrt{2}} \right) \times \left(\frac{\left(\frac{1-i}{2}\right)e^{-i\phi_x} - \left(\frac{1+i}{2}\right)e^{-i\phi_y}}{\sqrt{2}} \right) \\
&= \cos\phi_y \sin\phi_x - \cos\phi_x \sin\phi_y \\
&= \sin(\phi_x - \phi_y)
\end{aligned}$$

$$I_h - I_v \propto \sin(\phi_x - \phi_y)$$

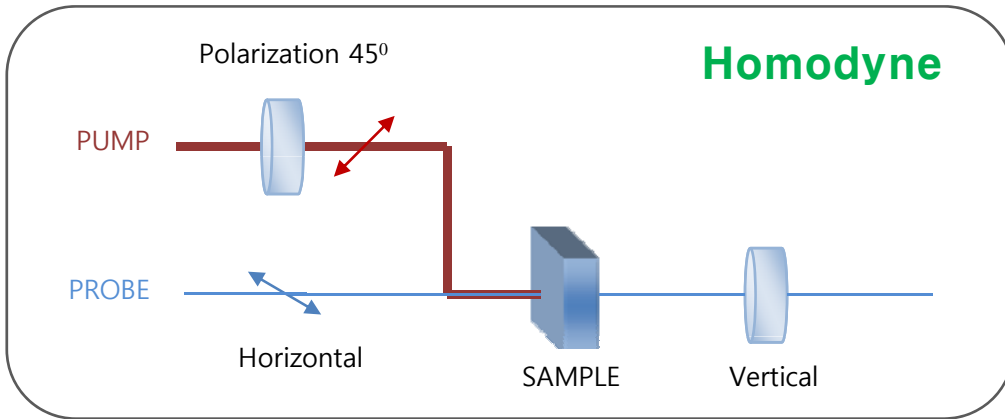

$$\sin\left(\frac{\phi_x - \phi_y}{2}\right)^2$$

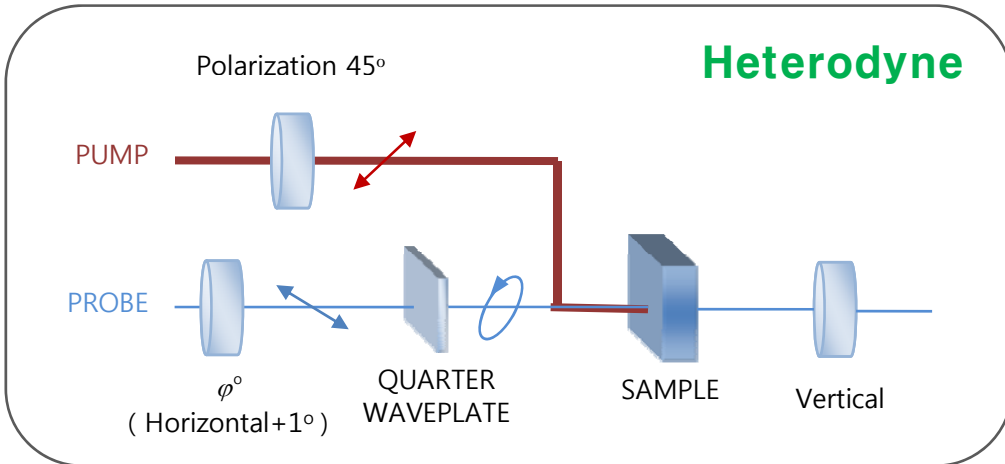

$$0.000306 - 0.000153 \sin\left(\frac{\phi_x - \phi_y}{2}\right)^2$$

$$+(5.35 \times 10^{-6}) \sin(\phi_x - \phi_y)$$

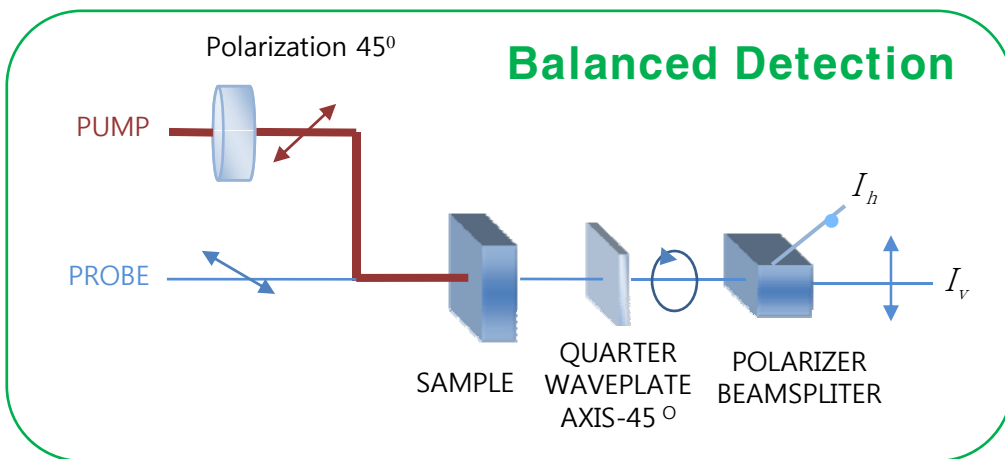

$$\sin(\phi_x - \phi_y)$$

output

Channel 1 Output	X, R, θ , or Trace 1-4. Traces are defined as A•B/C or A•B/C ² where A, B, and C are selected from the quantities Unity, X, Y, R, θ , Xnoise, Ynoise, Rnoise, Aux Inputs 1 through 4, or Frequency.	Trace 1 X
Channel 2 Output	Y, R, θ , or Trace 1-4. Traces are defined as A•B/C or A•B/C ² where A, B, and C are selected from the quantities Unity, X, Y, R, θ , Xnoise, Ynoise, Rnoise, Aux Inputs 1 through 4, or Frequency.	Trace 2 Y
	Output Voltage: ± 10 V full scale. 10 mA max output current.	Trace 3 R
	Output Voltage: ± 10 V full scale. 10 mA max output current.	Trace 4 θ



input

SIGNAL CHANNEL
 Voltage Inputs Single-ended (A) or differential (A-B).

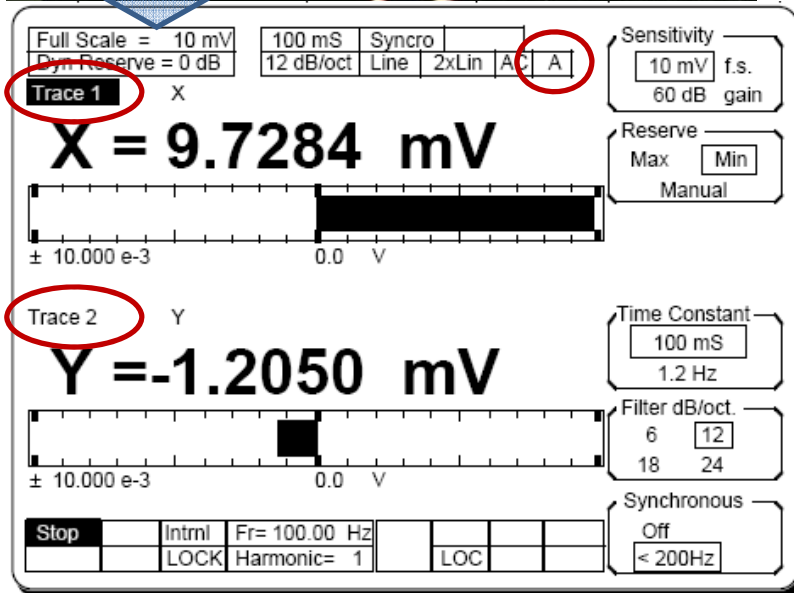

Source: A A-B I

Current Gain: 1M 100M

Grounding: Float Ground

Coupling: AC DC

Line Notches: Out Line Both 2xLine

Front Panel: CH1 CH2

Source: X

Offset & Expand: X Y R

Offset: 0.00%

Auto: []

Expand: 1

Trace: 1 2 3 4

X * 1

1

Do Not Store Store

Sample Rate: 1 Hz

Scan Length: 16000.0 4:26:40.0

1 Shot Loop

Source

CH1 can be proportional to X, R, θ , Trace1, Trace2, Trace3, or Trace 4.
 CH2 can be proportional to Y, R, θ , Trace1, Trace2, Trace3, or Trace 4.

When the unit is reset, the traces are defined as
 Trace 1 = X, Trace 2 = Y, Trace 3 = R, Trace 4 = θ .
 A•B/C or A•B/C²

The SR850 generates its own sine wave, shown as the lock-in reference below. The lock-in reference is $V_L \sin(\omega_L t + \theta_{ref})$.

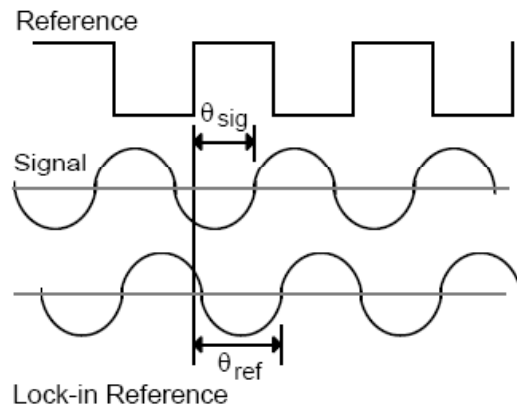

The SR850 amplifies the signal and then multiplies it by the lock-in reference using a phase-sensitive detector or multiplier. The output of the PSD is simply the product of two sine waves.

$$V_{psd} = V_{sig} V_L \sin(\omega_r t + \theta_{sig}) \sin(\omega_L t + \theta_{ref})$$

$$= \frac{1}{2} V_{sig} V_L \cos([\omega_r - \omega_L]t + \theta_{sig} - \theta_{ref}) - \frac{1}{2} V_{sig} V_L \cos([\omega_r + \omega_L]t + \theta_{sig} + \theta_{ref})$$

The PSD output is two AC signals, one at the difference frequency ($\omega_r - \omega_L$) and the other at the sum frequency ($\omega_r + \omega_L$).

If the PSD output is passed through a low pass filter, the AC signals are removed. What will be left? In the general case, nothing. However, if ω_r equals ω_L , the difference frequency component will be a DC signal. In this case, the filtered PSD output will be

$$V_{psd} = \frac{1}{2} V_{sig} V_L \cos(\theta_{sig} - \theta_{ref})$$

Magnitude and phase

Remember that the PSD output is proportional to $V_{sig} \cos\theta$ where $\theta = (\theta_{sig} - \theta_{ref})$. θ is the phase difference between the signal and the lock-in reference oscillator. By adjusting θ_{ref} we can make θ equal to zero, in which case we can measure V_{sig} ($\cos\theta=1$). Conversely, if θ is 90° , there will be no output at all. A lock-in with a single PSD is called a single-phase lock-in and its output is $V_{sig} \cos\theta$.

This phase dependency can be eliminated by adding a second PSD. If the second PSD multiplies the signal with the reference oscillator shifted by 90° , i.e. $V_L \sin(\omega_L t + \theta_{ref} + 90^\circ)$, its low pass filtered output will be

$$V_{psd2} = \frac{1}{2} V_{sig} V_L \sin(\theta_{sig} - \theta_{ref})$$

$$V_{psd2} \sim V_{sig} \sin\theta$$

Now we have two outputs, one proportional to $\cos\theta$ and the other proportional to $\sin\theta$. If we call the first output X and the second Y,

$$X = V_{sig} \cos\theta \quad Y = V_{sig} \sin\theta$$

these two quantities represent the signal as a vector relative to the lock-in reference oscillator. X is called the 'in-phase' component and Y the 'quadrature' component. This is because when $\theta=0$, X measures the signal while Y is zero.

By computing the magnitude (R) of the signal vector, the phase dependency is removed.

$$R = (X^2 + Y^2)^{1/2} = V_{sig}$$

R measures the signal amplitude and does not depend upon the phase between the signal and lock-in reference.

A dual-phase lock-in, such as the SR850, has two PSD's, with reference oscillators 90° apart, and can measure X, Y and R directly. In addition, the phase θ between the signal and lock-in reference, can be measured according to

$$\theta = \tan^{-1}(Y/X)$$